

# Clariflex®



## 150mm (6") ORBITAL SANDER/POLISHER MODEL NO: CP150

PART NO: 6462101

### OPERATION & MAINTENANCE INSTRUCTIONS



ORIGINAL INSTRUCTIONS

GC11/22 - Rev 1

---

## INTRODUCTION

---

Thank you for purchasing this CLARKE Sander/Polisher. The random orbit dual action means you won't polish the same section continuously, but it will oscillate in random orbits reducing the risk of damage to your vehicle's paintwork.

Before attempting to use this product, please read this manual thoroughly and follow the instructions carefully. In doing so you will ensure the safety of yourself and that of others around you, and you can look forward to your purchase giving you long and satisfactory service.

This product has been designed to give long and trouble free service. If, however, having followed the instructions in this booklet carefully, you encounter problems take the unit to your local CLARKE dealer.

---

## GUARANTEE

---

This product is guaranteed against faulty manufacture for a period of 12 months from the date of purchase. Please keep your receipt which will be required as proof of purchase.

This guarantee is invalid if the product is found to have been abused or tampered with in any way, or not used for the purpose for which it was intended.

Faulty goods should be returned to their place of purchase, no product can be returned to us without prior permission.

This guarantee does not effect your statutory rights.

---

## ENVIRONMENTAL RECYCLING POLICY

---



Through purchase of this product, the customer is taking on the obligation to deal with the WEEE in accordance with the WEEE regulations in relation to the treatment, recycling & recovery and environmentally sound disposal of the WEEE.

In effect, this means that this product must not be disposed of with general household waste. It must be disposed of according to the laws governing Waste Electrical and Electronic Equipment (WEEE) at a recognised disposal facility.

---

# GENERAL POWER TOOL SAFETY WARNINGS

---



**WARNING: READ ALL SAFETY WARNINGS AND ALL INSTRUCTIONS. FAILURE TO FOLLOW THE WARNINGS AND INSTRUCTIONS MAY RESULT IN ELECTRIC SHOCK, FIRE AND/OR SERIOUS INJURY.**

---

Save all warnings and instructions for future reference.

The term "power tool" in the warnings refers to your mains-operated sander/polisher.

## WORK AREA SAFETY

1. **Keep work area clean and well lit.** Cluttered or dark areas invite accidents.
2. **Do not operate power tools in explosive atmospheres, such as in the presence of flammable liquids, gases or dust.** Power tools create sparks which may ignite the dust or fumes.
3. **Keep children and bystanders away while operating a power tool.** Distractions can cause you to lose control.

## ELECTRICAL SAFETY

1. **Power tool plugs must match the outlet. Never modify the plug in any way. Do not use any adapter plugs with earthed (grounded) power tools.** Unmodified plugs and matching outlets will reduce risk of electric shock.
2. **Avoid body contact with earthed or grounded surfaces, such as pipes, radiators, ranges and refrigerators.** There is an increased risk of electric shock if your body is earthed or grounded.
3. **Do not expose power tools to rain or wet conditions.** Water entering a power tool will increase the risk of electric shock.
4. **Do not abuse the power cable. Never use the cable for carrying, pulling or unplugging the power tool. Keep the cable away from heat, oil, sharp edges or moving parts.** Damaged or entangled cables increase the risk of electric shock.
5. **When operating a power tool outdoors, use an extension cable suitable for outdoor use.** Use of a cable suitable for outdoor use reduces the risk of electric shock.
6. **If operating a power tool in a damp location is unavoidable, use a residual current device (RCD) protected supply.** Use of an RCD reduces the risk of electric shock.

## PERSONAL SAFETY

1. **Stay alert, watch what you are doing and use common sense when operating a power tool. Do not use a power tool while you are tired or under the influence of drugs, alcohol or medication.** A moment of inattention while operating power tools may result in serious personal injury.
2. **Use personal protective equipment. Always wear eye and ear protection.** Protective equipment such as dust mask, non-skid safety shoes, hard hat, or hearing protection used for appropriate conditions will reduce personal injuries.
3. **Prevent unintentional starting. Ensure the switch is in the off position before connecting to power source, picking up or carrying the tool.** Carrying power tools with your finger on the switch or energising power tools that have the switch on invites accidents.
4. **Remove any adjusting key or wrench before turning the power tool on.** A wrench or a key left attached to a rotating part of the power tool may result in personal injury.
5. **Do not overreach. Keep proper footing and balance at all times.** This enables better control of the power tool in unexpected situations.
6. **Dress properly. Do not wear loose clothing or jewellery. Keep your hair, clothing and gloves away from moving parts.** Loose clothes, jewellery or long hair can be caught in moving parts.
7. **If devices are provided for the connection of dust extraction and collection facilities, ensure these are connected and properly used.** Use of dust collection can reduce dust-related hazards.
8. **Hold the power tool by insulated gripping surfaces, when performing an operation where the fastener may contact hidden wiring or its own cord.** Fasteners contacting a "Live" wire may make exposed metal parts of the power tool "Live" and could give the operator an electric shock.

## POWER TOOL USE AND CARE

1. **Do not force the power tool. Use the correct power tool for your application.** The correct power tool will do the job better and safer at the rate for which it was designed.
2. **Do not use the power tool if the switch does not turn it on and off.** Any power tool that cannot be controlled with the switch is dangerous and must be repaired.
3. **Disconnect the plug from the power source and/or the battery pack from the power tool before making any adjustments, changing accessories, or storing power tools.** Such preventive safety measures reduce the risk of starting the power tool accidentally.

4. **Store idle power tools out of the reach of children and do not allow persons unfamiliar with the power tool or these instructions to operate the power tool.** Power tools are dangerous in the hands of untrained users.
5. **Maintain power tools. Check for misalignment or binding of moving parts, breakage of parts and any other condition that may affect the power tool's operation. If damaged, have the power tool repaired before use.** Many accidents are caused by poorly maintained power tools.
6. **Keep cutting tools sharp and clean.** Properly maintained cutting tools with sharp cutting edges are less likely to bind and are easier to control.
7. **Use the power tool, accessories and tool bits etc. in accordance with these instructions, taking into account the working conditions and the work to be performed.** Use of the power tool for operations different from those intended could result in a hazardous situation.



## SERVICE

1. **Have your power tool serviced by a Clarke service centre using only identical replacement parts.** This will ensure that the safety of the power tool is maintained.

---

## SAFETY SYMBOLS

---

	<p>Read instruction manual before use</p>
	<p>Wear safety glasses</p>
	<p>Wear protective dust mask</p>

## ELECTRICAL CONNECTIONS



**WARNING: READ THESE ELECTRICAL SAFETY INSTRUCTIONS FULLY BEFORE CONNECTING THE MACHINE TO THE MAINS SUPPLY.**

This product is provided with a standard 13 amp, 230 volt (50Hz), BS 1363 plug, for connection to a standard, domestic electrical supply. Should the plug need changing, make sure that a plug of identical specification is used.



**WARNING: THE WIRES IN THE CABLE ARE COLOURED AS FOLLOWS:  
BLUE = NEUTRAL    BROWN = LIVE**

If the colours of the wires in the power cable do not correspond with the markings on the terminals of your plug, proceed as follows.

- Connect the **blue** wire to the terminal marked **N**.
- Connect the **brown** wire to the terminal marked **L**.

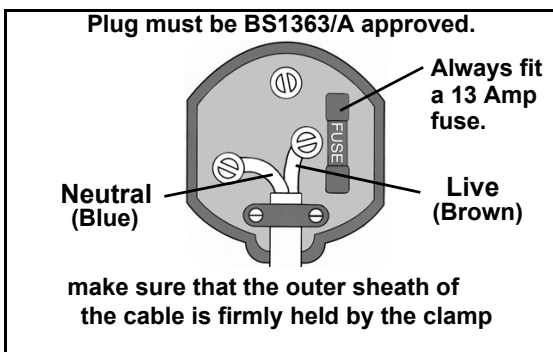

**We recommend that this machine is connected to the mains supply via a Residual Current Device (RCD)**

If in doubt, consult a qualified electrician. DO NOT attempt any repairs yourself



**This symbol indicates that this is a Class II product and does not require an earth connection.**

## EXTENSION CABLES

Always use an approved cable extension suitable for the power rating of this tool (see specifications), the conductor size should also be at least the same size as that on the machine, or larger. When using a cable reel, always unwind the cable completely.

# OVERVIEW

When unpacking, check for damage or shortages etc. Any found should be reported to your CLARKE dealer where the machine was originally purchased.

:

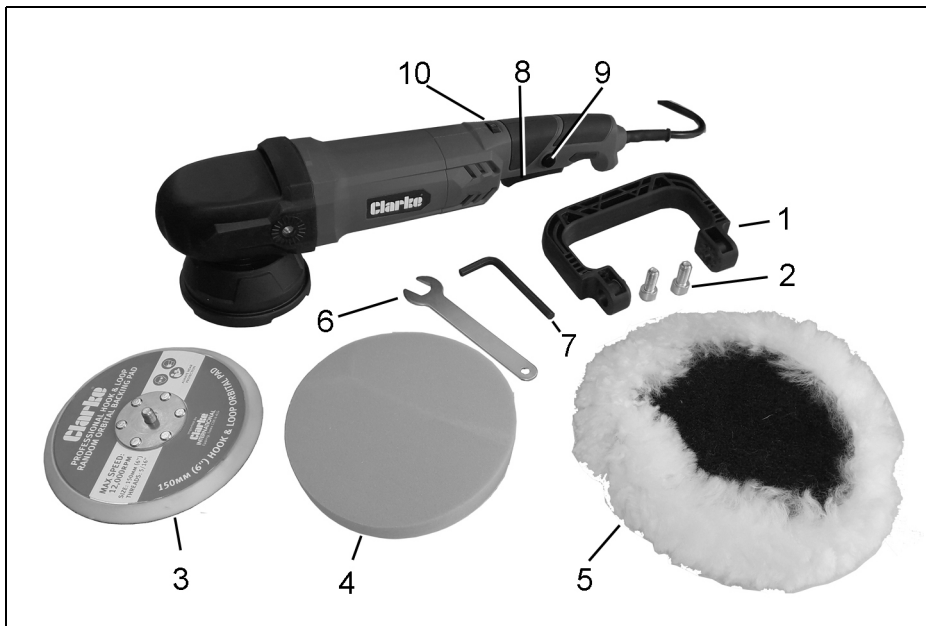

NO	DESCRIPTION	NO	DESCRIPTION
1	'D' Handle	6	14 mm Spanner
2	Handle Fixing Bolts	7	6 mm Hexagon Key
3	150 mm Backing Disc	8	Trigger
4	150 mm Sponge Pad	9	Trigger Lock Button
5	Polishing Bonnet	10	Speed Controller

---

## BEFORE USE

---



**WARNING: MAKE SURE THAT THE MACHINE IS SWITCHED OFF AND UNPLUGGED FROM THE MAINS SUPPLY BEFORE FITTING OR REMOVING THE 'D' HANDLE OR BACKING PAD.**

---

### FITTING THE 'D' HANDLE

1. Fit the 'D' handle onto the body of the machine and secure with two allen screws supplied.
  - Tighten using the 6 mm Hex key provided.
  - the handle can be set at different angles.
  - DO NOT overtighten.



### FITTING THE BACKING DISC

1. Lock the spindle using the spanner supplied while screwing on the backing disc by hand.
  - The spanner will rest in the groove shown, in the machine body.
  - Either the polishing bonnet, sponge pad or a sanding disc can be fitted to the backing disc.

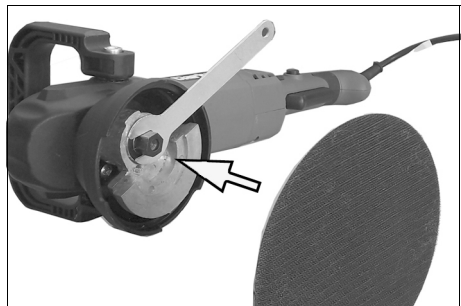

### MOUNTING OF ACCESSORIES

1. Press either the sponge pad or polishing bonnet onto the 'hook & eye' covered backing disc. Peel the sponge pad or polishing bonnet off the hook and eye surface to remove from the backing pad.
2. Before using the machine ensure that the backing disc and accessory are correctly mounted and firmly tightened.
3. Check that the backing disc and accessory runs freely by turning it by hand and then test-run the machine for at least 30 seconds at highest no-load speed in a safe position. Stop immediately in case of excessive vibration or other defects and check to determine the cause.



---

## OPERATION

---

Whether polishing or sanding, always make sure that any loose workpiece is securely fixed ie. clamped to a workbench or secured in a vice.

- When working on car bodywork, the vibration may cause any items left on the car body to fall down.
- Always keep the work area tidy.

### STARTING THE MACHINE

1. Adjust the speed control marked 1-6 to the desired working speed.
2. Hold the machine firmly with both hands and squeeze the trigger. The motor will then run.

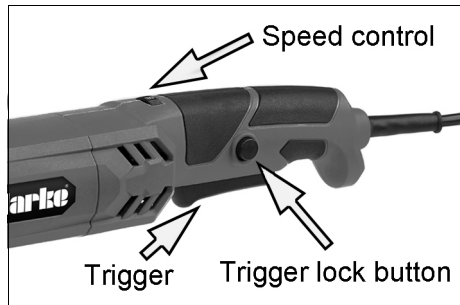

### CONTINUOUS OPERATION

1. Press and hold the trigger lock button whilst holding the trigger in and the machine will run continuously.
  - The machine will continue to run even if the trigger is released.
2. To release the trigger lock button, squeeze the trigger, then release and the motor will stop.
3. Slowly apply the machine to the workpiece and proceed to sand or polish. Move the disc across the work applying a light even pressure.



**WARNING: ENSURE THAT THE WORKING POSITION ADOPTED DOES NOT CAUSE OPERATOR FATIGUE WHICH MAY LEAD TO LOSS OF CONTROL**

4. If it is necessary to change the speed, always lift the disc from the work surface, adjust the speed control to the required speed then reapply to the work surface and continue as before.

### STOPPING WORK

1. On completion, lift the machine from the work surface and release the trigger
  - Ensure the motor has come to a complete stop before setting the machine down on the workbench etc. Failure to do so can cause the machine to be thrown, resulting in damage or personal injury.

---

# MAINTENANCE

---



**WARNING: BEFORE COMMENCING ANY MAINTENANCE PROCEDURES, ALWAYS ENSURE THE MACHINE IS ISOLATED FROM THE ELECTRICAL SUPPLY BY SWITCHING OFF AND REMOVING THE PLUG FROM THE POWER SOCKET.**

---

1. Ensure all air ventilation slots are clear, (Use compressed air to clean the machine if possible. **Always wear protective goggles when cleaning with compressed air.**)
2. Check the power cable to ensure it is sound and free from cracks, bare wires etc. Avoid using solvents when cleaning plastic parts, (most plastics are susceptible to damage from the various types of commercial solvents).
3. All bearings etc, in this machine are lubricated with sufficient high grade lubricant for the machine's lifetime under normal operating conditions, therefore no further lubrication is required.
4. Refer to your CLARKE dealer if internal maintenance is required.

## FAULTFINDING

Problem	Possible Cause	Remedy
Tool will not operate.	No power supply.	Check supply and rectify as necessary.
	Faulty switch.	Consult your Clarke dealer.
	Fuse blown.	Replace fuse as on page 6.
	Faulty motor.	Consult your Clarke dealer.
Motor runs but pad does not rotate.	Drive gear broken.	Consult your Clarke dealer.
Heavy internal sparking.	Faulty motor.	Consult your Clarke dealer.
Motor becomes hot.	Unduly heavy use.	Reduce the force applied to the machine. Let the machine do the work.
	Air vents have become blocked.	Clean out the air vents using compressed air or clean with a dry cloth. Use PPE when working with compressed air.
	Low supply voltage.	Ensure supply voltage is correct. If an extension cable is used, ensure it is of the correct rating and is fully unwound.
Excessive vibration.	Disc not mounted correctly.	Check and rectify.
	Machine bearings worn.	Consult your Clarke dealer.

## SPECIFICATIONS

Item	Specification
Dimensions (L x W x H)	400 x 120 x 100 mm
Weight	2.6 kg
Backing pad type	Polymer with 'hook & loop' system
Disc Diameter	150 mm
Operating voltage & Frequency	230V ~ 50 Hz
Orbit (pitch circle diameter)	21 mm
Fuse Rating	13 A
Motor Power	900 W
No Load Speed	0-6000 rpm
Sound Pressure Level dB LWA	80.27 dB
Guaranteed Sound Power Level dB LWA	91.27 dB
Uncertainty factor	3 dB
Vibration (front handle)	6.759 m/s <sup>2</sup>
Uncertainty factor	1.5 m/s <sup>2</sup>

Please note that the details and specifications contained herein, are correct at the time of going to print. However, CLARKE International reserve the right to change specifications at any time without prior notice.

# DECLARATIONS OF CONFORMITY





Fitzwilliam Hall, Fitzwilliam Place, Dublin 2

**DECLARATION OF CONFORMITY**

**This is an important document and should be retained.**

**We hereby declare that this product(s) complies with the following directive(s):**

- 2014/30/EU Electromagnetic Compatibility Directive
- 2006/42/EC Machinery Directive
- 2011/65/EU Restriction of the Use of Certain Hazardous Substances in Electrical & Electronic Equipment (RoHS) Directive

**The following standards have been applied to the product(s):**

- EN 55014-1:2017, EN 55014-2:2015, EN IEC 61000-3-2:2019, EN 61000-3-2:2013 + A1,
- EN 62841-1:2015, EN 62841-2-4:2014, IEC 62321-1:2013, IEC 62321-2:2013,
- IEC 62321-3-1:2013, IEC 62321-4:2013 + AMD1:2017 CSV, IEC 62321-5:2013, IEC 62321-6:2015,
- IEC 62321-7-1:2015, IEC 62321-7-2:2017, IEC 62321-8:2017, ISO 17075:2017.

The technical documentation required to demonstrate that the product(s) meet(s) the requirement(s) of the aforementioned directive(s) has been compiled and is available for inspection by the relevant enforcement authorities.

**The CE mark was first applied in: 2019**

<b>Product Description:</b>	150mm (6") Pro Dual Action Sander/Polisher
<b>Model number(s):</b>	CP150
<b>Serial / batch Number:</b>	N/A
<b>Date of Issue:</b>	20/10/2022

**Signed:**  J.A. Clarke  
Director

Page 1 of 1  
CP150 CE Clarke DOC 1100302





Hemnell Street, Epping, Essex CM16 4LG

**DECLARATION OF CONFORMITY**

**This is an important document and should be retained.**

**We hereby declare that this product(s) complies with the following statutory requirement(s):**

- Electromagnetic Compatibility Regulations 2016
- Supply of Machinery (Safety) Regulations 2008
- The Restriction of the Use of Certain Hazardous Substances in Electrical and Electronic Equipment Regulations 2012

**The following standards have been applied to the product(s):**

- EN 55014-1:2017, EN 55014-2:2015, EN IEC 61000-3-2:2019, EN 61000-3-2:2013 + A1,
- EN 62841-1:2015, EN 62841-2-4:2014, IEC 62321-1:2013, IEC 62321-2:2013,
- IEC 62321-3-1:2013, IEC 62321-4:2013 + AMD1:2017 CSV, IEC 62321-5:2013, IEC 62321-6:2015,
- IEC 62321-7-1:2015, IEC 62321-7-2:2017, IEC 62321-8:2017, ISO 17075:2017.

The technical documentation required to demonstrate that the product(s) meet(s) the requirement(s) of the aforementioned legislation has been compiled and is available for inspection by the relevant enforcement authorities.

**The UKCA mark was first applied in: 2022**

<b>Product Description:</b>	150mm (6") Pro Dual Action Sander/Polisher
<b>Model number(s):</b>	CP150
<b>Serial / batch Number:</b>	N/A
<b>Date of Issue:</b>	20/10/2022

**Signed:**  J.A. Clarke  
Director

Page 1 of 1  
CP150 UKCA Clarke DOC 110032

# PARTS LIST & DIAGRAM

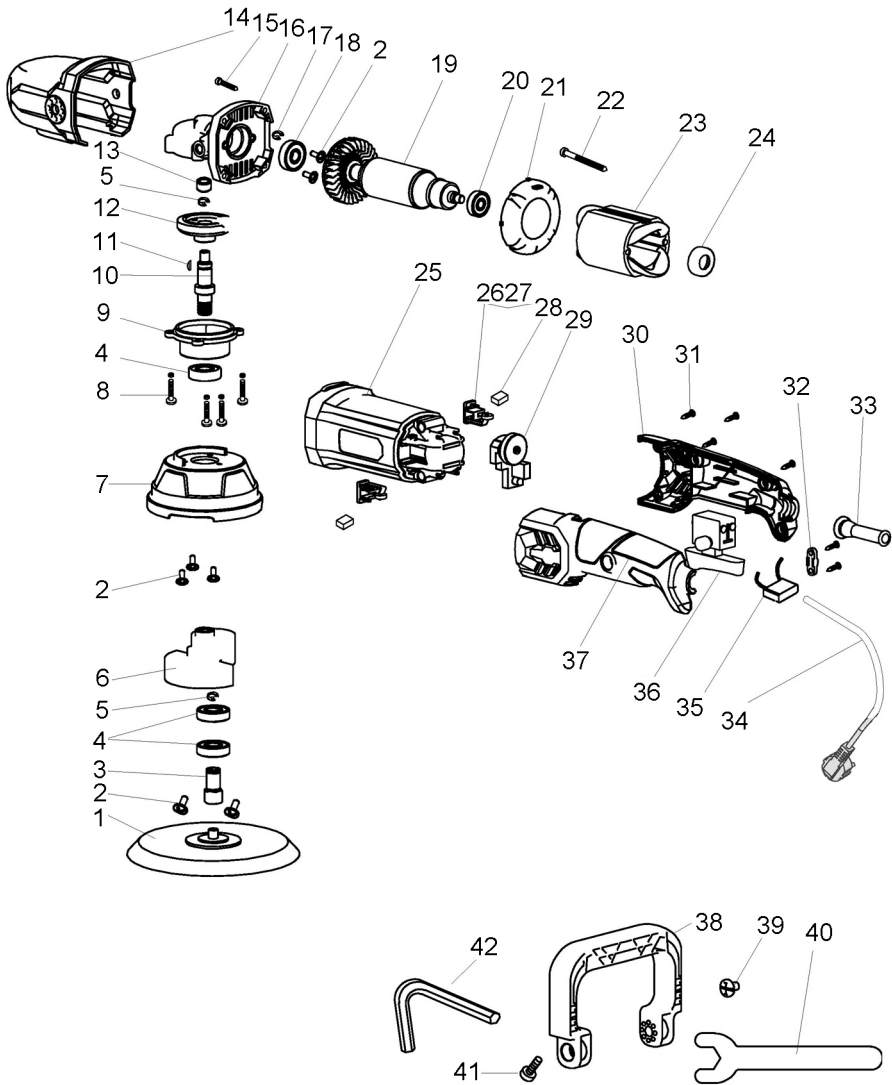

## COMPONENT PARTS LIST

No	Description
1	Backing disc
2	Screw M5 x 8
3	Spindle II
4	Bearing 6001-2RS
5	Lock Spring 12
6	Energy block
7	Cover
8	Screw M4 x 14
9	Front cover
10	Spindle
11	Woodruff key 3x 10
12	Large gear
13	Needle bearing HK0810
14	Gearbox cover
15	Screw ST3.9x25
16	Gearbox
17	Lock spring 10
18	Bearing 6000-2RS
19	Rotor
20	Bearing 627-2Z
21	Draft shield

No	Description
22	Screw ST3.9x60
23	Stator
24	608 bearing cover
25	Main housing
26	Carbon brush holder
27	Disc spring
28	Carbon brush
29	Speed adjuster
30	Right casing
31	Screw ST3.9x14
32	Strain relief
33	Cable gland
34	Power cable
35	Capacitor
36	Switch
37	Left casing
38	Handle
39	Screw
40	Spanner
41	Screw M8x20
42	Allen key

## CONSUMABLE ITEMS

Replacement Foam Polishing Sponges, Polishing Bonnets and Sanding Discs (Grit 40, 60, 80) are available from your Clarke dealer.

# A SELECTION FROM THE VAST RANGE OF

# Clarke®

## QUALITY PRODUCTS



### **AIR COMPRESSORS**

From DIY to industrial, Plus air tools, spray guns and accessories.

### **GENERATORS**

Prime duty or emergency standby for business, home and leisure.

### **POWER WASHERS**

Hot and cold, electric and engine driven - we have what you need

### **WELDERS**

Mig, Arc, Tig and Spot.  
From DIY to auto/industrial.

### **METALWORKING**

Drills, grinders and saws for DIY and professional use.

### **WOODWORKING**

Saws, sanders, lathes, mortisers and dust extraction.

### **HYDRAULICS**

Cranes, body repair kits, transmission jacks for all types of workshop use.

### **WATER PUMPS**

Submersible, electric and engine driven for DIY, agriculture and industry.

### **POWER TOOLS**

Angle grinders, cordless drill sets, saws and sanders.

### **STARTERS/CHARGERS**

All sizes for car and commercial use.

## **PARTS & SERVICE:**

## **0208 988 7400**

### **Parts Enquiries**

[Parts@clarkeinternational.com](mailto:Parts@clarkeinternational.com)

### **Servicing & Technical Enquiries**

[Service@clarkeinternational.com](mailto:Service@clarkeinternational.com)

SALES: UK 01992 565333 or Export 00 44 (0)1992 565335

**Clarke** INTERNATIONAL Hemnall Street, Epping, Essex CM16 4LG  
[www.clarkeinternational.com](http://www.clarkeinternational.com)